

# AF Series contactors for motor starting and power switching up to 2850 Amp

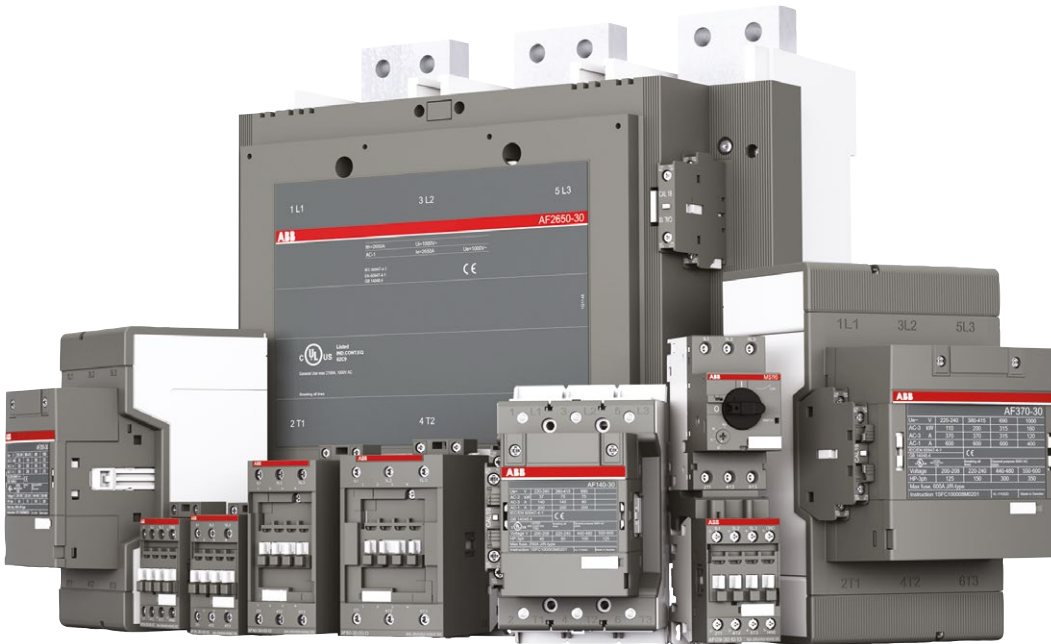

## INDEX

**AF Series General Overview ..... pg 2-6**

**3 pole, 9 amp - 38 amp ..... pg 7**

**3 pole, 40 amp - 96 amp ..... pg 8**

**9 amp - 96 amp Accessories..... pg 9**

**3 pole, 116 amp - 146 amp ..... pg 10**

**3 pole, 190 amp - 370 amp ..... pg 11**

**116 amp - 370 amp Accessories..pg 12**

**Technical Data ..... pg 13-19**

# AF technology

## Main Benefits



### Conventional AC coil

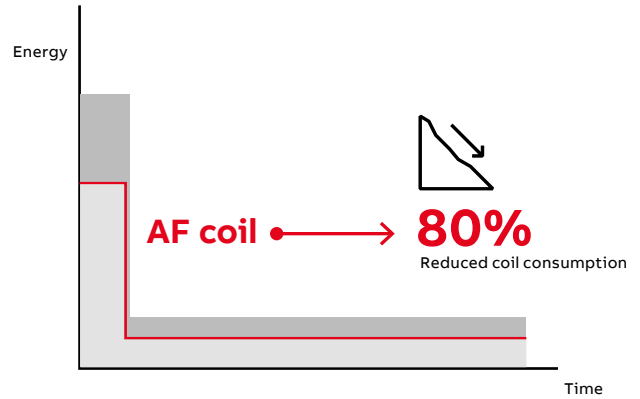

### Reliable in all networks

The electronic system within the AF contactor continuously monitor the current and voltage apply to the coil. The contactor is safely operated in an always optimized condition and hum free.

### Reduced coil consumption

AF coil and energy consumption is reduced up to 80%. This allows a reduction of the temperature rise, the size of control transformers and size of cabinets.

### AF coil

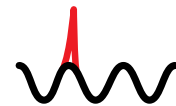
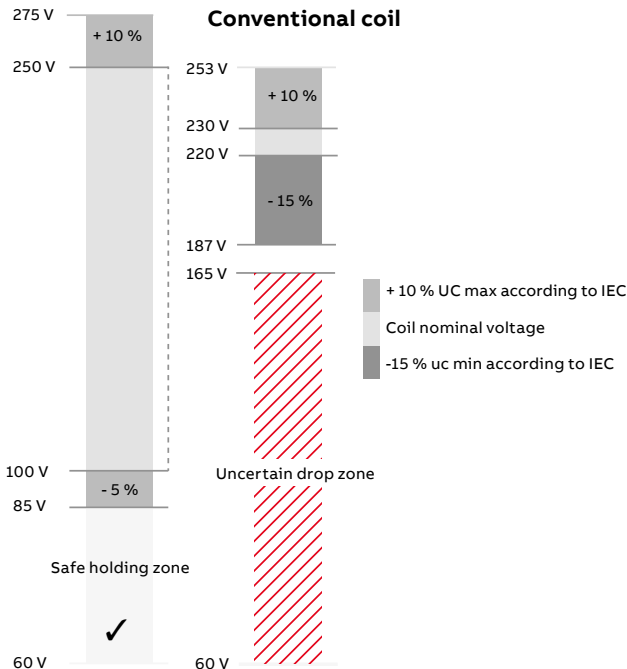

### Wide control voltage range

With conventional contactor technology, different contactors are needed for different network voltages. Thanks to the wide operating range of the AF contactor, it can operate just as well in Europe as in Asia or North America. The core coil of the AF contactor range covers 100-250 V AC / DC, 50 / 60 Hz.

### Built-in surge suppression

With conventional contactor technology, it is recommended to use an external surge suppressor, an accessory that could cost as much as half of the contactor. With the AF technology, the surges are handled by the contactor and never reach the control circuit. One less product and one less complication to worry about.

# Contactors and motor protection

## Advanced but simple

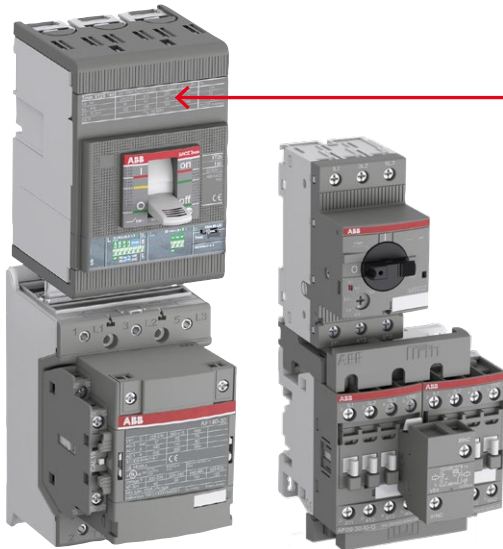

### Easy, fast and secure starters assembly

The AF contactor range is perfect for motor starting applications and for solutions where space is limited. You can create any motor starting type and save assembly time with a complete range of accessories and connection sets.

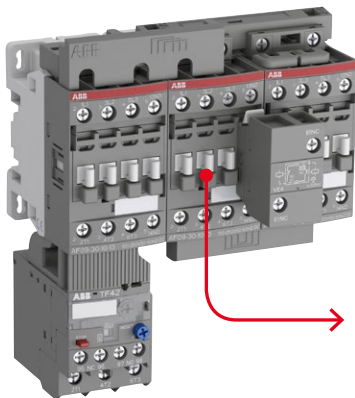

### Protect from overload in all conditions

Select thermal overload relays (trip class 10) or electronic overload relays (trip class 10E, 20E, 30E in the same product) to protect your motors against overload and phase failure.

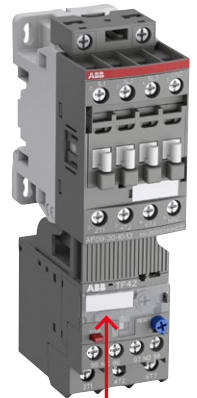

### Compact size

The AF contactor is compact in size and has had its width reduced by up to 30% thanks to an 80% coil consumption reduction.



### Save space

Interlocking reversing pairs require no spacing between contactors, meaning you can fit more functionality into cabinets or other enclosures.

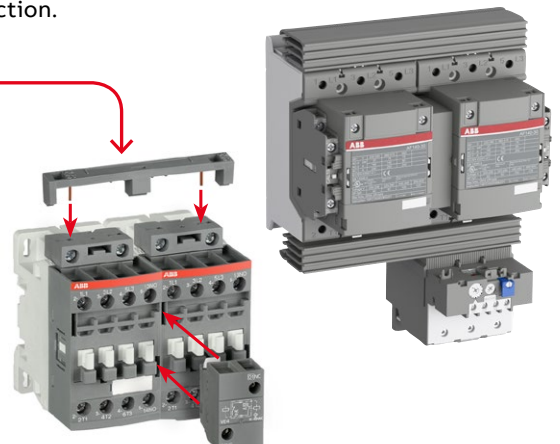

# Contactors and motor protection

## Flexible and safe

### Easy to use accessories

#### Up to 96 A

**Great flexibility for coil terminal access**  
 Contactors offer free choice of coil terminal access from top, bottom, both top and bottom or front.

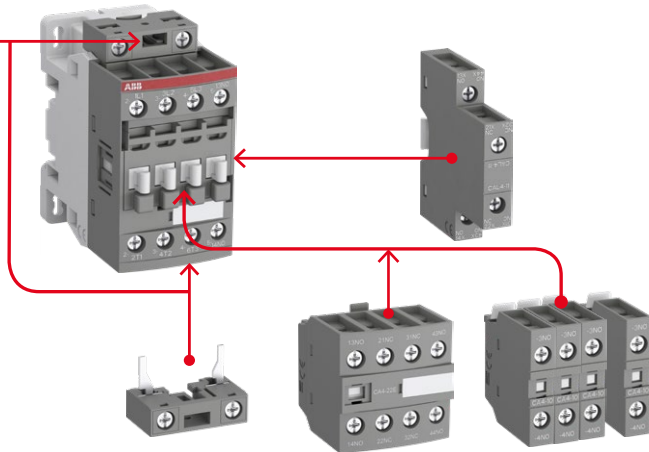

**Easy to use accessories**  
 1-pole, 2-pole and 4-pole auxiliary contact blocks, front or side mounted, are available for a great flexibility.

#### Up to 2850 A

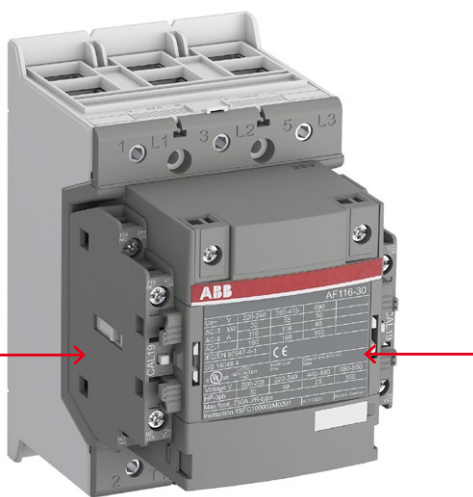

**2 side mounted auxiliary contact blocks**  
 AF116 ... AF2850 contactors can take up to 2 side mounted auxiliary contact blocks without adding to its width. Coil connection terminals, mechanical and electrical interlocks and electronic timers are easily connected through the snap-to-connect function.

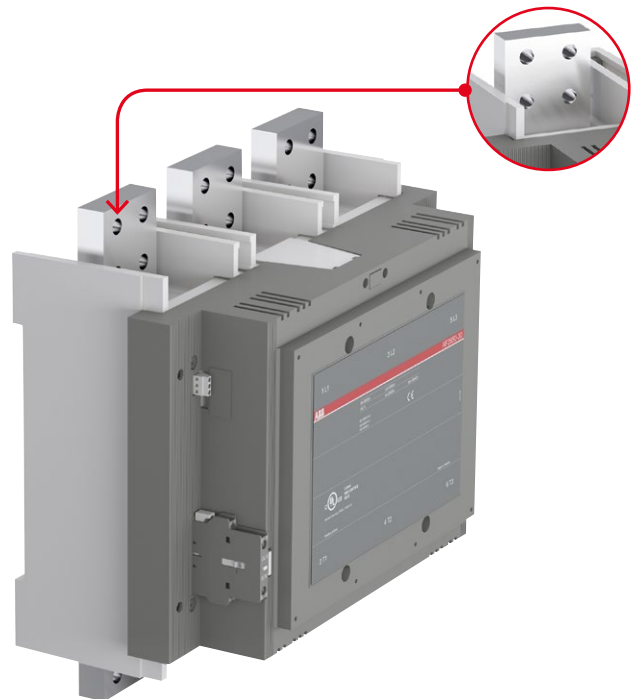

**Simple connection and maintenance**  
 The main terminals of AF116 ... AF2850 contactors are at the contactors' back to facilitate your bus bars connections. It also allows easy contact inspection and maintenance from AF400 and above.

# 3-pole contactors, for motor control and power switching



AC / DC Control supply				Type	AF09	AF12	AF16	AF26	AF30	AF38	AF40	AF52	AF65	AF80	AF96
IEC	AC-3	Rated operational power	220 - 230 - 240 V	kW	2.2	3	4	6.5	9	11	11	15	18.5	22	25
			380 - 400 V	kW	4	5.5	7.5	11	15	18.5	18.5	22	30	37	45
		θ ≤ 60 °C for AF09 ... AF370 θ ≤ 55 °C for AF400 ... AF2650	415 V	kW	4	5.5	9	11	15	18.5	22	30	37	45	55
			440 V	kW	4	5.5	9	15	18.5	22	22	30	37	45	55
			500 V	kW	5.5	7.5	9	15	18.5	22	22	30	37	45	55
		690 V	kW	5.5	7.5	9	15	18.5	22	22	30	37	45	55	
		1000 V	kW	—	—	—	—	—	—	—	—	—	—	—	35
Rated operational current	380 - 400 V	A	9	12	18	26	32	38	40	53	65	80	96		
AC-1	Rated operational current	θ ≤ 40 °C, 690 V	A	25	28	30	45	50	50	70	100	105	125	130	

UL / CSA	1-phase motor rating	120 V	hp	0.75	1	1.5	2	2	2	3	3	5	7.5	7.5
		240 V	hp	1.5	2	3	3	5	5	7.5	10	15	15	20
	3-phase motor rating	200 - 208 V	hp	2	3	5	7.5	10	10	10	15	20	25	30
		220 - 240 V	hp	2	3	5	7.5	10	10	15	20	25	30	30
		440 - 480 V	hp	5	7.5	10	15	20	25	30	40	50	60	60
	General use rating	550 - 600 V	hp	7.5	10	15	20	25	30	40	50	60	75	75
600 V		A	25	28	30	45	50	50	60	80	90	105	115	
NEMA	NEMA Size			00	0	—	1	—	—	2	—	—	3	—

## Main accessories

Auxiliary contact blocks	Front mounting	CA4-10 (1 x N.O.) CA4-01 (1 x N.C.)			
	Side mounting	CAL4-11 (1 x N.O. + 1 x N.C.)			
Timers	Electronic	TEF4-ON TEF4-OFF			
	Interlocking units	Mechanical	VM4	VM96-4	
	Mechanical / Electrical	VEM4			
Connection sets	For reversing contactors	BER16-4	BER38-4	BER65-4	BER96-4
Surge suppressors		Built-in surge protection			

## Overload relays

	Thermal relays	Class 10 (Class 10A for TF140, TA200DU)	TF42 (0.10...38 A)	TF65 (22...67 A)	TF96 (40...96 A)
	Electronic relays	Class 10E, 20E, 30E	EF19 (0.10...18.9 A)	EF19 (0.10...18.9 A) EF45 (9...45 A)	EF65 (20...70 A)

## Manual motor starters

	Thermal / magnetic protection Class 10	MS116 (0.10...32 A) lcs up to 50 kA for class 10 A	MS165 (10...80 A) lcs up to 100 kA (1)	
	Magnetic only types	MS132 (0.10...32 A) lcs up to 100 kA	MO165 (16...80 A) lcs up to 100 kA (1)	
Accessories	For contactor mounting	BEA16-4	BEA38-4	BEA65-4 (2)

(1) MS165/MO165 are suitable for use with AF09 ... AF30 for North American applications.

(2) BEA65-4 suitable for MS165 and MO165 only.



AF116	AF140	AF146	AF190	AF205	AF265	AF305	AF370	AF400	AF460	AF580	AF750	AF1250	AF1350	AF1650	AF2050	AF2650	AF2850
30	37	45	55	55	75	90	110	110	132	160	220	—	257	315	—	—	—
55	75	75	90	110	132	160	200	200	250	315	400	—	475	560	—	—	—
55	75	75	90	110	132	160	200	220	250	355	425	—	500	630	—	—	—
75	90	90	110	132	160	160	200	220	250	355	450	—	560	710	—	—	—
75	90	90	110	132	160	200	250	250	315	400	520	—	560	710	—	—	—
55	75	90	132	160	200	250	315	315	355	500	600	—	800	1000	—	—	—
—	—	75	110	132	160	185	200	220	280	355	400	—	—	—	—	—	—
116	140	146	190	205	265	305	370	400	460	580	750	—	860	1060	—	—	—
160	200	225	275	350	400	500	600	600	700	800	1050	1260	1350	1650	2050	2650	2850

—	—	—	—	—	—	—	—	—	—	—	—	—	—	—	—	—	—
—	—	—	—	—	—	—	—	—	—	—	—	—	—	—	—	—	—
30	40	40	50	60	75	100	125	125	150	200	250	—	—	—	—	—	—
40	50	50	60	75	100	125	150	150	200	250	300	—	400	450	—	—	—
75	100	100	125	150	200	250	300	350	400	500	600	—	800	900	—	—	—
100	125	125	150	200	250	300	350	400	500	600	700	—	1000	1150	—	—	—
160	200	200	250	300	350	400	520	550	650	750	900	1210	1350	1650	2100	2700	2850
—	4	—	—	—	5	—	—	—	6	—	7	—	—	8	—	—	—

CAL19-11 (1 x N.O. + 1 x N.C.)				CAL18-11 (1 x N.O. + 1 x N.C.)										
VM19 (for same size contactors)				VM750H VM750V				VM1650H						
BER140-4			BER205-4			BER370-4			BEM460-30			BEM750-30		

TF140DU (66...142 A) $\theta \leq 55^\circ\text{C}$		TA200DU (66...200 A) $\theta \leq 55^\circ\text{C}$											
EF146 (54...150 A)		EF205 (63...210 A)		EF370 (115...380 A)		EF460 (150...500 A)		EF750 (250...800 A)		EF1250DU (350...1250 A)			

# AF09 ... AF38 3-pole contactors

4 to 18.5 kW

AC / DC operated



AF09-30-10



AF26-30-00

AF09 ... AF38 contactors are mainly used for controlling 3-phase motors and power circuits up to 690 V AC and 220 V DC. These contactors are of the block type design with 3 main poles.

- control circuit: AC or DC operated with electronic coil interface accepting a wide control voltage range (e.g. 100...250 V AC and DC), only 4 control voltage ranges covering 24...500 V 50/60 Hz and 20...500 V DC
  - can manage large control voltage variations
  - reduced panel energy consumption
  - very distinct closing and opening.
- built-in surge suppression
- add-on auxiliary contact blocks for front or side mounting and a wide range of accessories.

IEC Rated operational power 400 V AC-3 kW	UL/CSA 3-phase motor rating 480 V AC-1 A	General use rating 600 V AC hp	General use rating A	Rated control circuit voltage Uc min. ... Uc max.		Auxiliary contacts fitted	Type	Order code	Weight Pkg (1 pce) kg				
				V 50/60 Hz	V DC								
4	25	5	25	24...60	20...60	(1)	1 0	AF09-30-10-11	1SBL137001R1110	0.270			
							0 1	AF09-30-01-11	1SBL137001R1101	0.270			
							1 0	AF09-30-10-12	1SBL137001R1210	0.270			
							0 1	AF09-30-01-12	1SBL137001R1201	0.270			
							1 0	AF09-30-10-13	1SBL137001R1310	0.270			
							0 1	AF09-30-01-13	1SBL137001R1301	0.270			
				100...250	100...250	1 0	AF09-30-10-14	1SBL137001R1410	0.310				
										0 1	AF09-30-01-14	1SBL137001R1401	0.310
										1 0	AF12-30-10-11	1SBL157001R1110	0.270
										0 1	AF12-30-01-11	1SBL157001R1101	0.270
										1 0	AF12-30-10-12	1SBL157001R1210	0.270
										0 1	AF12-30-01-12	1SBL157001R1201	0.270
100...250	100...250	1 0	AF12-30-10-13	1SBL157001R1310	0.270								
						0 1	AF12-30-01-13	1SBL157001R1301	0.270				
						1 0	AF12-30-10-14	1SBL157001R1410	0.310				
						0 1	AF12-30-01-14	1SBL157001R1401	0.310				
						1 0	AF16-30-10-11	1SBL177001R1110	0.270				
						0 1	AF16-30-01-11	1SBL177001R1101	0.270				
100...250	100...250	1 0	AF16-30-10-12	1SBL177001R1210	0.270								
						0 1	AF16-30-01-12	1SBL177001R1201	0.270				
						1 0	AF16-30-10-13	1SBL177001R1310	0.270				
						0 1	AF16-30-01-13	1SBL177001R1301	0.270				
						1 0	AF16-30-10-14	1SBL177001R1410	0.310				
						0 1	AF16-30-01-14	1SBL177001R1401	0.310				
100...250	100...250	1 0	AF16-30-10-14	1SBL177001R1410	0.310								
						0 1	AF16-30-01-14	1SBL177001R1401	0.310				
						0 0	AF26-30-00-11	1SBL237001R1100	0.310				
						0 0	AF26-30-00-12	1SBL237001R1200	0.310				
						0 0	AF26-30-00-13	1SBL237001R1300	0.310				
						0 0	AF26-30-00-14	1SBL237001R1400	0.350				
15	50	20	50	24...60	20...60	(1)	0 0	AF30-30-00-11	1SBL277001R1100	0.310			
							0 0	AF30-30-00-12	1SBL277001R1200	0.310			
							0 0	AF30-30-00-13	1SBL277001R1300	0.310			
							0 0	AF30-30-00-14	1SBL277001R1400	0.350			
							0 0	AF38-30-00-11	1SBL297001R1100	0.310			
							0 0	AF38-30-00-12	1SBL297001R1200	0.310			
18.5	50	25	50	24...60	20...60	(1)	0 0	AF38-30-00-13	1SBL297001R1300	0.310			
							0 0	AF38-30-00-14	1SBL297001R1400	0.350			

(1) AF...-30...-11 not suitable for direct control by PLC-output.

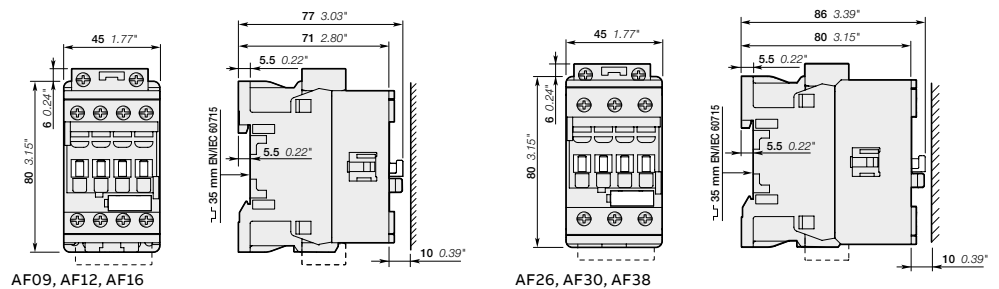

AF09, AF12, AF16

AF26, AF30, AF38

Main dimensions mm, inches

# AF40 ... AF96 3-pole contactors

18.5 to 45 kW

AC / DC operated



AF40-30-00



AF80-30-00

- AF40 ... AF96 contactors are mainly used for controlling 3-phase motors and power circuits up to 1000 V AC and 220 V DC. These contactors are of the block type design with 3 main poles.
- control circuit: AC or DC operated with electronic coil interface accepting a wide control voltage range (e.g. 100...250 V AC and DC), only 4 control voltage ranges covering 24...500 V 50/60 Hz and 20...500 V DC
    - can manage large control voltage variations
    - reduced panel energy consumption
    - very distinct closing and opening
    - can withstand short voltage dips and voltage sags (SEMI F47-0706 conditions of use on request).
  - built-in surge suppression
  - add-on auxiliary contact blocks for front or side mounting and a wide range of accessories.

IEC Rated operational power	UL / CSA 3-phase motor rating	General use rating	Rated control circuit voltage		Auxiliary contacts fitted	Type (1)	Order code	Weight
			Uc min. ...	Uc max.				
400 V AC-3	480 V	600 V AC	V 50/60 Hz	V DC				
kW	hp	A						Pkg (1 pce) kg
18.5	30	60	24...60	20...60 (1)	0 0	AF40-30-00-11	1SBL347001R1100	0.970
			48...130	48...130	0 0	AF40-30-00-12	1SBL347001R1200	0.970
			100...250	100...250	0 0	AF40-30-00-13	1SBL347001R1300	0.950
			250...500	250...500	0 0	AF40-30-00-14	1SBL347001R1400	0.950
22	40	80	24...60	20...60 (1)	0 0	AF52-30-00-11	1SBL367001R1100	0.970
			48...130	48...130	0 0	AF52-30-00-12	1SBL367001R1200	0.970
			100...250	100...250	0 0	AF52-30-00-13	1SBL367001R1300	0.950
			250...500	250...500	0 0	AF52-30-00-14	1SBL367001R1400	0.950
30	50	90	24...60	20...60 (1)	0 0	AF65-30-00-11	1SBL387001R1100	0.970
			48...130	48...130	0 0	AF65-30-00-12	1SBL387001R1200	0.970
			100...250	100...250	0 0	AF65-30-00-13	1SBL387001R1300	0.950
			250...500	250...500	0 0	AF65-30-00-14	1SBL387001R1400	0.950
37	60	105	24...60	20...60 (1)	0 0	AF80-30-00-11	1SBL397001R1100	1.220
			48...130	48...130	0 0	AF80-30-00-12	1SBL397001R1200	1.220
			100...250	100...250	0 0	AF80-30-00-13	1SBL397001R1300	1.170
			250...500	250...500	0 0	AF80-30-00-14	1SBL397001R1400	1.170
45	60	115	24...60	20...60 (1)	0 0	AF96-30-00-11	1SBL407001R1100	1.220
			48...130	48...130	0 0	AF96-30-00-12	1SBL407001R1200	1.220
			100...250	100...250	0 0	AF96-30-00-13	1SBL407001R1300	1.170
			250...500	250...500	0 0	AF96-30-00-14	1SBL407001R1400	1.170

(1) For control by PLC-output, use RA4 interface relay.

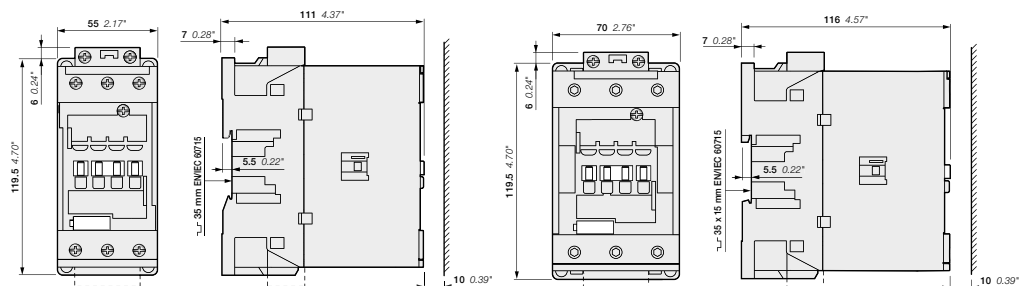

AF40, AF52, AF65

AF80, AF96

Main dimensions mm, inches



# AF09 ... AF96 3-pole contactors

## Contactors and main accessories

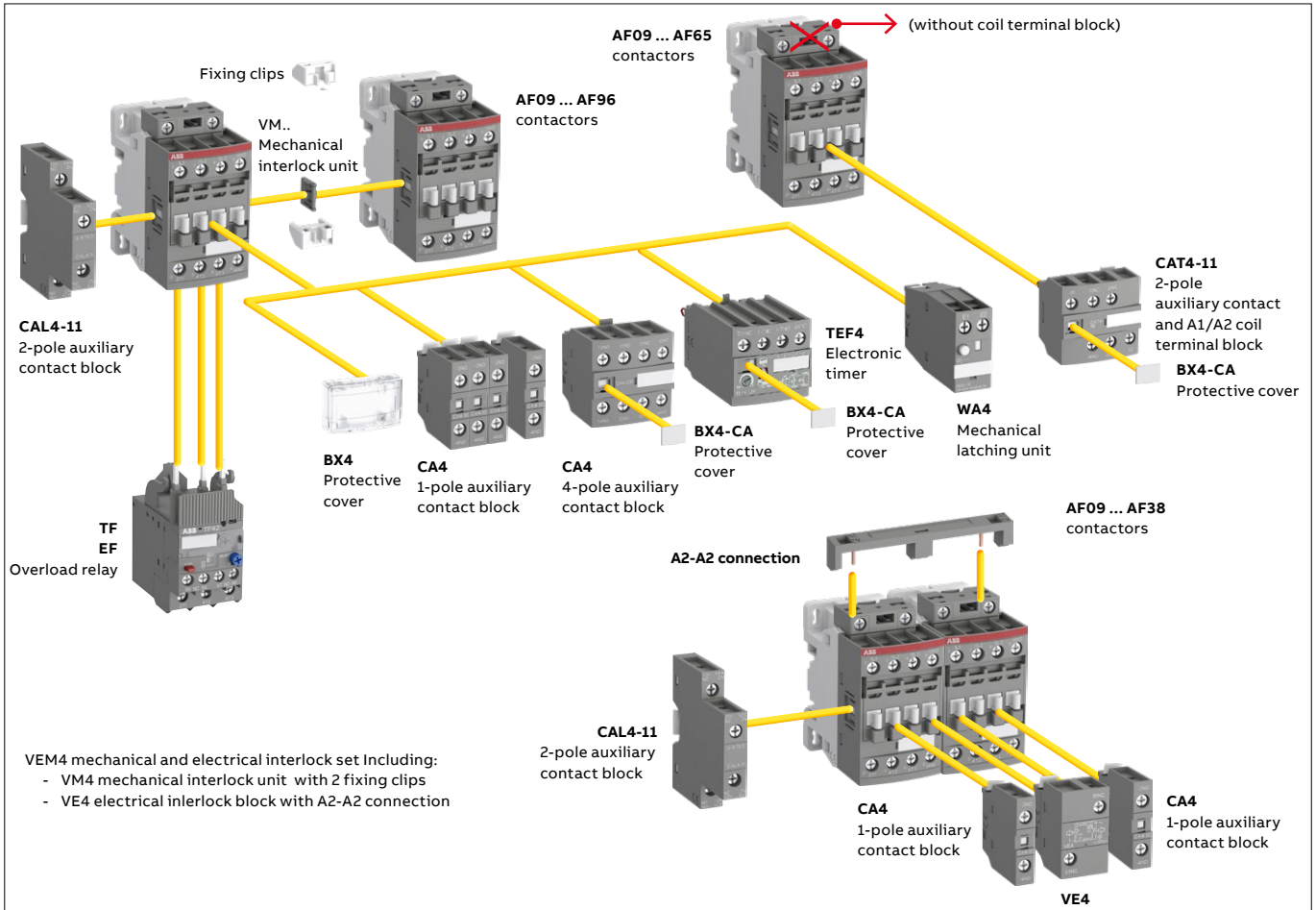

**Main accessory fitting details** - for ordering details, technical data and other accessories: see section accessories  
 Many configurations of accessories are possible depending on whether these are front-mounted or side-mounted.

Contactor types	Main poles	Built-in auxiliary contacts	Front-mounted accessories			Electronic timer	Mechanical latching unit	Electrical and mechanical interlock set (between 2 contactors)	Side-mounted accessories	
			Auxiliary contact blocks						Auxiliary contact blocks	
			1-pole CA4	2-pole CAT4-11	4-pole CA4	TEF4	WA4 (2)	VEM4	Left side	Right side
<b>AF09(Z) ... AF38(Z) (1)</b>										
AF09 ... AF16	3 0 0 1	▶	4 max.	or 1	or 1	or 1	or 1	-	+ 1	-
AF09 ... AF16	3 0 1 0	▶	2 max.	or 1	-	or 1	or 1	-	+ 1	+ 1
AF26 ... AF38	3 0 0 0	▶	3 max.	-	-	-	-	+ 1 (3)	+ 1	or 1
<b>AF09Z ... AF38Z 24 V DC designed for PLC - coil 30 (1)</b>										
AF09Z ... AF16Z	3 0 0 1	▶	4 max.	-	or 1	or 1	-	-(3)	or 1	+ 1
AF09Z ... AF16Z	3 0 1 0	▶	2 max.	-	-	or 1	-	-(3)	+ 1	or 1
AF26Z ... AF38Z	3 0 0 0	▶	-	-	-	1	-	-	+ 1	+ 1
<b>AF40 ... AF96</b>										
AF40 ... AF65	3 0 0 0	▶	4 max.	or 1	or 1	or 1	or 1	-	+ 1	+ 1
AF80, AF96	3 0 0 0	▶	4 max.	-	or 1	or 1	or 1	-	+ 1	+ 1

(1) Including add-on and built-in contacts : 4 N.C. auxiliary contacts max on positions 1, 2, 3, 4 and 3 N.C. auxiliary contacts max. on positions 1+30°, 5.  
 (2) Use WA4 for AF09...AF65 and WA4-96 for AF80, AF96.  
 Accept 1-pole CA4 auxiliary contacts (1 block on each side of the mechanical latch) in respect to the total number of built-in or additional N.C. auxiliary contacts.  
 For WA4 accessory use with contactor coil 30, please consult your ABB local sales organization.  
 (3) VEM4 not suitable for AF..Z contactors with DC control voltages 12...20 V DC (coil 20) and 24 V DC (coil 30). Use VM4 side-mounted mechanical interlock unit.

### Overload relays fitting details (4)

Contactor types	Thermal overload relays	Electronic overload relays
AF09 ... AF38	TF42 (0.10...38 A)	EF19 (0.10...19 A)
AF26 ... AF38	TF42 (0.10...38 A)	EF45 (9...45 A)
AF40 ... AF65	TF65 (22...67 A)	EF65 (20...70 A)
AF80, AF96	TF96 (40...96 A)	EF96 (36...100 A)

The addition of an overload relay on the contactor does not prevent fitting of many other accessories as shown above.  
 (4) Direct mounting - No kit required.

# AF116 ... AF146 3-pole contactors

55 to 75 kW

AC / DC operated



AF146-30-00



AF146-30-00B

AF116 ... AF140 contactors are mainly used for controlling 3-phase motors and power circuits up to 690 V AC, AF146 up to 1000 V AC and AF116 ... AF146 up to 260 V DC. These contactors are of the block type design with 3 main poles.

- control circuit: AC or DC operated with electronic coil interface accepting a wide control voltage range (e.g. 100...250 V AC and DC), only 4 coils to cover control voltages between 24...500 V 50/60 Hz and 20...500 V DC
  - can manage large control voltage variations
  - reduced panel energy consumption
  - very distinct closing and opening
  - can withstand short voltage dips and voltage sags (SEMI F47 conditions of use on request).
- built-in surge suppression
- add-on auxiliary contact blocks for side mounting and a wide range of accessories.

IEC		UL / CSA		Rated control circuit voltage Uc min. ... Uc max.	Auxiliary contacts fitted	Type (1)	Order code	Weight Pkg (1 pce) kg
Rated operational power	current $\theta \leq 40^\circ\text{C}$	3-phase motor rating 480 V	General use rating 600 V AC					
400 V	AC-3	A	hp	V 50/60 Hz	V DC			
kW	A	A	A					

**For connection with built-in cable clamps**

55	160	75	160	24...60	20...60	0 0	AF116-30-00-11	1SFL427001R1100	1.750
				48...130	48...130	0 0	AF116-30-00-12	1SFL427001R1200	1.750
				100...250	100...250	0 0	AF116-30-00-13	1SFL427001R1300	1.750
				250...500	250...500	0 0	AF116-30-00-14	1SFL427001R1400	1.750
75	200	100	200	24...60	20...60	0 0	AF140-30-00-11	1SFL447001R1100	1.750
				48...130	48...130	0 0	AF140-30-00-12	1SFL447001R1200	1.750
				100...250	100...250	0 0	AF140-30-00-13	1SFL447001R1300	1.750
				250...500	250...500	0 0	AF140-30-00-14	1SFL447001R1400	1.750
75	225	100	200	24...60	20...60	0 0	AF146-30-00-11	1SFL467001R1100	1.750
				48...130	48...130	0 0	AF146-30-00-12	1SFL467001R1200	1.750
				100...250	100...250	0 0	AF146-30-00-13	1SFL467001R1300	1.750
				250...500	250...500	0 0	AF146-30-00-14	1SFL467001R1400	1.750

**With bar connections**

55	160	75	160	24...60	20...60	0 0	AF116-30-00B-11	1SFL427002R1100	1.500
				48...130	48...130	0 0	AF116-30-00B-12	1SFL427002R1200	1.500
				100...250	100...250	0 0	AF116-30-00B-13	1SFL427002R1300	1.500
				250...500	250...500	0 0	AF116-30-00B-14	1SFL427002R1400	1.500
75	200	100	200	24...60	20...60	0 0	AF140-30-00B-11	1SFL447002R1100	1.500
				48...130	48...130	0 0	AF140-30-00B-12	1SFL447002R1200	1.500
				100...250	100...250	0 0	AF140-30-00B-13	1SFL447002R1300	1.500
				250...500	250...500	0 0	AF140-30-00B-14	1SFL447002R1400	1.500
75	225	100	200	24...60	20...60	0 0	AF146-30-00B-11	1SFL467002R1100	1.500
				48...130	48...130	0 0	AF146-30-00B-12	1SFL467002R1200	1.500
				100...250	100...250	0 0	AF146-30-00B-13	1SFL467002R1300	1.500
				250...500	250...500	0 0	AF146-30-00B-14	1SFL467002R1400	1.500

(1) For other auxiliary contacts arrangements, please contact your local sales organization.

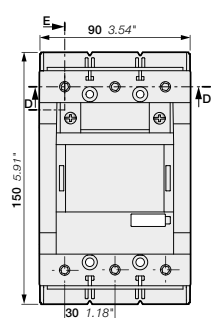

AF116, AF140, AF146-30-00

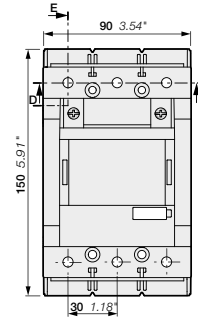
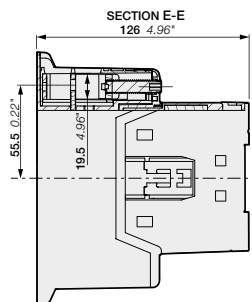

AF116, AF140, AF146-30-00B

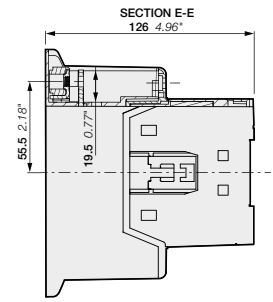

Main dimensions mm, inches

## AF190 ... AF370 3-pole contactors

90 to 200 kW  
 AC / DC operated

## Contact Springer Controls for 400....2850 Amp 3-pole Contactors



AF205-30-00



AF370-30-00

AF190 ... AF370 contactors are mainly used for controlling 3-phase motors and power circuits up to 1000 V AC and 340 V DC. These contactors are of the block type design with 3 main poles.

- control circuit: AC or DC operated with electronic coil interface accepting a wide control voltage range (e.g. 100...250 V AC and DC), only 4 coils to cover control voltages between 24...500 V 50/60 Hz and 20...500 V DC
  - can manage large control voltage variations
  - reduced panel energy consumption
  - very distinct closing and opening
  - can withstand short voltage dips and voltage sags (SEMI F47 conditions of use on request).
- built-in surge suppression
- add-on auxiliary contact blocks for side mounting and a wide range of accessories.

IEC Rated power 400 V AC-3 kW	operational current $\theta \leq 40^\circ\text{C}$ AC-1 A	UL / CSA		Rated control circuit voltage Uc min. ... Uc max. V 50/60 Hz   V DC	Auxiliary contacts fitted 	Type (1)	Order code	Weight Pkg (1 pce) kg	
		3-phase motor rating 480 V hp	General use rating 600 V AC A						
90	275	125	250	24...60	20...60	0 0	AF190-30-00-11	1SFL487002R1100	3.000
				48...130	48...130	0 0	AF190-30-00-12	1SFL487002R1200	3.000
				100...250	100...250	0 0	AF190-30-00-13	1SFL487002R1300	3.000
				250...500	250...500	0 0	AF190-30-00-14	1SFL487002R1400	3.000
110	350	150	300	24...60	20...60	0 0	AF205-30-00-11	1SFL527002R1100	3.000
				48...130	48...130	0 0	AF205-30-00-12	1SFL527002R1200	3.000
				100...250	100...250	0 0	AF205-30-00-13	1SFL527002R1300	3.000
				250...500	250...500	0 0	AF205-30-00-14	1SFL527002R1400	3.000
132	400	200	350	24...60	20...60	0 0	AF265-30-00-11	1SFL547002R1100	4.605
				48...130	48...130	0 0	AF265-30-00-12	1SFL547002R1200	4.605
				100...250	100...250	0 0	AF265-30-00-13	1SFL547002R1300	4.605
				250...500	250...500	0 0	AF265-30-00-14	1SFL547002R1400	4.605
160	500	250	400	24...60	20...60	0 0	AF305-30-00-11	1SFL587002R1100	4.605
				48...130	48...130	0 0	AF305-30-00-12	1SFL587002R1200	4.605
				100...250	100...250	0 0	AF305-30-00-13	1SFL587002R1300	4.605
				250...500	250...500	0 0	AF305-30-00-14	1SFL587002R1400	4.605
200	600	300	520	24...60	20...60	0 0	AF370-30-00-11	1SFL607002R1100	4.605
				48...130	48...130	0 0	AF370-30-00-12	1SFL607002R1200	4.605
				100...250	100...250	0 0	AF370-30-00-13	1SFL607002R1300	4.605
				250...500	250...500	0 0	AF370-30-00-14	1SFL607002R1400	4.605

(1) For other auxiliary contacts arrangements, please contact your ABB local sales organization.

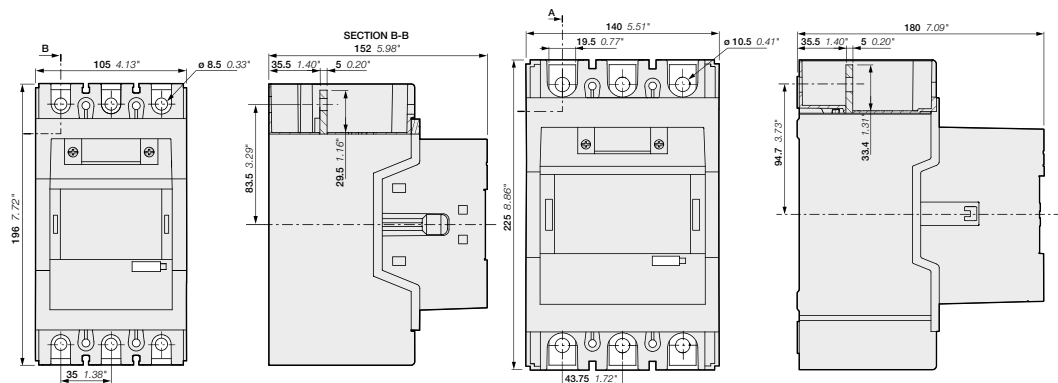

AF190, AF205

AF265, AF305, AF370

Main dimensions mm, inches

# AF116 ... AF370 3-pole contactors

## Contactors and main accessories

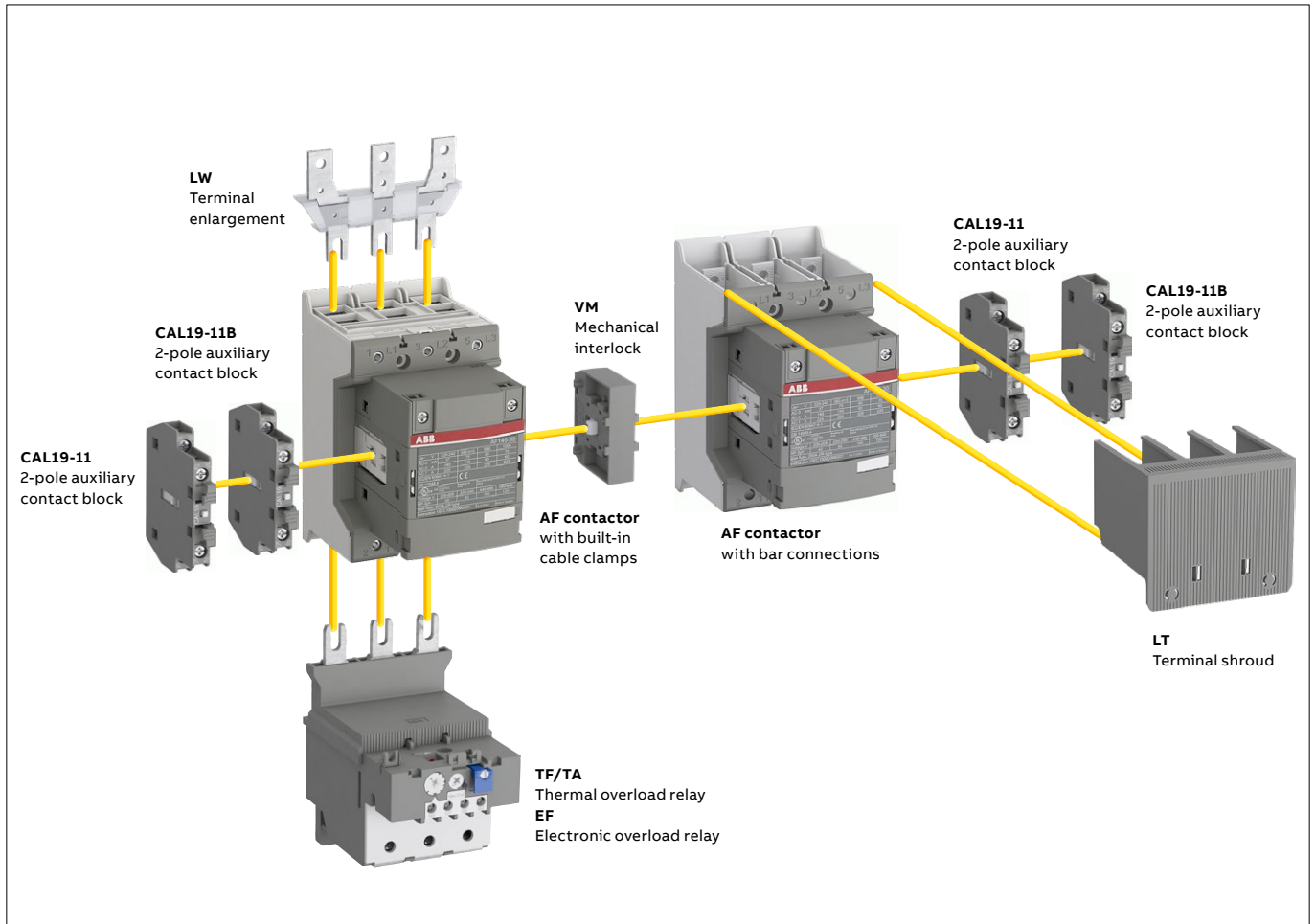

**Main accessory fitting details - for ordering details, technical data and other accessories: see section accessories**

Contactor types	Main poles	Available auxiliary contacts	Side-mounted accessories		Mechanical interlock units (between two contactors)
			Auxiliary contact blocks		
			<b>CAL19-11 (3)</b>	<b>CAL19-11B</b>	
AF116 ... AF370	3	0 0	▶ 2 x CAL19-11	+ 2 x CAL19-11B	-
AF116 ... AF370	3	0 0	▶ 2 x CAL19-11 (1)	+ 2 x CAL19-11B (1)	+ VM... (2)

- (1) Total number of auxiliary contact blocks for the two contactors.
- (2) Interlock type, according to the contactor ratings (see "Accessories").
- (3) The CEL19 auxiliary contact blocks can replace the CAL19-11 and CAL19-11B. Though, no auxiliary contact block can be mounted outside the CEL19.

**Overload relays fitting details (1)**

Contactor types	Thermal overload relays	Electronic overload relays
AF116 ... AF140	TF140DU (66...142 A)	EF146 (54...150 A)
AF146	-	EF146 (54...150 A)
AF190, AF205	TA200DU (66...200 A)	EF205 (63...210 A)
AF265 ... AF370	-	EF370 (115...380 A)

The addition of a thermal or electronic overload relay on the contactor does not prevent fitting of many other accessories as shown in "Main accessory fitting details" table.  
(1) Direct mounting - No kit required.

# AF09 ... AF38 3-pole contactors

## Technical data

### Main pole - Utilization characteristics according to UL / NEMA / CSA

Contactors types	AC / DC operated	AF09	AF12	AF16	AF26	AF30	AF38		
Standards		UL 508, CSA C22.2 N°60947-4-1							
Maximum operational voltage		600 V							
NEMA size		00	0	-	1	-	-		
NEMA continuous amp rating	Thermal current	9 A	18 A		27 A				
NEMA maximum horse power ratings 1-phase, 60 Hz	115 V AC	1/3 hp	1 hp		2 hp				
	230 V AC	1 hp	2 hp		3 hp				
NEMA maximum horse power ratings 3-phase, 60 Hz	200 V AC	1-1/2 hp	3 hp		7-1/2 hp				
	230 V AC	1-1/2 hp	3 hp		7-1/2 hp				
	460 V AC	2 hp	5 hp		10 hp				
	575 V AC	2 hp	5 hp		10 hp				
UL / CSA general use rating	600 V AC	25 A	28 A	30 A	45 A	50 A	50 A		
	With conductor cross-sectional area	AWG 10	AWG 10	AWG 10	AWG 8	AWG 8	AWG 8		
	1 pole	80 V DC	25 A	28 A	30 A	45 A	50 A	50 A	
	2 poles in serie	160 V DC	25 A	28 A	30 A	45 A	50 A	50 A	
	3 poles in serie	240 V DC	25 A	28 A	30 A	45 A	50 A	50 A	
	With conductor cross-sectional area		AWG 10	AWG 10	AWG 10	AWG 8	AWG 8	AWG 8	
	UL / CSA maximum 1-phase motor rating								
Full load current	120 V AC	13.8 A	16 A	20 A	24 A	24 A	24 A		
	240 V AC	10 A	12 A	17 A	17 A	28 A	28 A		
Horse power rating	120 V AC	3/4 hp	1 hp	1-1/2 hp	2 hp	2 hp	2 hp		
	240 V AC	1-1/2 hp	2 hp	3 hp	3 hp	5 hp	5 hp		
UL / CSA maximum 3-phase motor rating	Full load current (1)	200-208 V AC	7.8 A	11 A	17.5 A	25.3 A	32.2 A	32.2 A	
		220-240 V AC	6.8 A	9.6 A	15.2 A	22 A	28 A	28 A	
		440-480 V AC	7.6 A	11 A	14 A	21 A	27 A	34 A (3)	
		550-600 V AC	9 A	11 A	17 A	22 A	27 A (2)	32 A (3)	
	Horse power rating (1)	200-208 V AC	2 hp	3 hp	5 hp	7-1/2 hp	10 hp	10 hp	
		220-240 V AC	2 hp	3 hp	5 hp	7-1/2 hp	10 hp	10 hp	
		440-480 V AC	5 hp	7-1/2 hp	10 hp	15 hp	20 hp	25 hp (3)	
		550-600 V AC	7-1/2 hp	10 hp	15 hp	20 hp	25 hp (2)	30 hp (3)	
	UL / CSA - DC motor starting - 3 poles in series	Full Load Amps (FLA)	125 V DC	9.5 A	13.2 A	17 A	25 A	25 A	25 A
			250 V DC	8.5 A	12.2 A	12.2 A	20 A	29 A	29 A
Horse power rating		125 V DC	1 hp	1-1/2 hp	2 hp	3 hp	3 hp	3 hp	
		250 V DC	2 hp	3 hp	3 hp	5 hp	7-1/2 hp	7-1/2 hp	
Short-circuit protection device for contactors without thermal overload relay - Motor protection excluded									
High fault current		100 kA							
Fuse rating		30 A	30 A	60 A	60 A	100 A	100 A		
Fuse type, 600 V		J							
Max. electrical switching frequency									
For general use		600 cycles/h							
For motor use		1200 cycles/h							

(1) For the corresponding kW/A or hp/A values of 1500 r.p.m, 50 Hz or 1800 r.p.m, 60 Hz, 3-phase motors, see "Motor rated operational powers and currents".

(2) For contactors produced since week 49-2011.

(3) For contactors produced since week 36-2014.

# AF40 ... AF96 3-pole contactors

## Technical data

### Main pole - Utilization characteristics according to UL / NEMA / CSA

Contactor types	AC / DC operated	AF40	AF52	AF65	AF80	AF96	
Standards		UL 60947-4-1, CSA C22.2 N°60947-4-1					
Maximum operational voltage		600 V					
NEMA size		2	-	-	3	-	
NEMA continuous amp rating	Thermal current	45 A	-	-	90 A	-	
NEMA maximum horse power ratings 1-phase, 60 Hz	115 V AC	3 hp	-	-	-	-	
	230 V AC	7.5 hp	-	-	-	-	
NEMA maximum horse power ratings 3-phase, 60 Hz	200 V AC	10 hp	-	-	25 hp	-	
	230 V AC	15 hp	-	-	30 hp	-	
	460 V AC	25 hp	-	-	50 hp	-	
	575 V AC	25 hp	-	-	50 hp	-	
UL / CSA general use rating	600 V AC	60 A	80 A	90 A	105 A	115 A	
	With conductor cross-sectional area	AWG 6	AWG 4	AWG 3	AWG 2	AWG 2	
	1 pole	80 V DC	60 A	80 A	90 A	105 A	115 A
	2 poles in serie	160 V DC	60 A	80 A	90 A	105 A	115 A
	3 poles in serie	240 V DC	60 A	80 A	90 A	105 A	115 A
	With conductor cross-sectional area		AWG 6	AWG 4	AWG 3	AWG 2	AWG 2
UL / CSA maximum 1-phase motor rating	Full load current	120 V AC	34 A	34 A	56 A	80 A	80 A
		240 V AC	40 A	50 A	68 A	68 A	88 A
	Horse power rating	120 V AC	3 hp	3 hp	5 hp	7-1/2 hp	7-1/2 hp
		240 V AC	7-1/2 hp	10 hp	15 hp	15 hp	20 hp
UL / CSA maximum 3-phase motor rating	Full load current (1)	200-208 V AC	32.2 A	48.3 A	62.1 A	78.2 A	92 A
		220-240 V AC	42 A	54 A	68 A	80 A	80 A
		440-480 V AC	40 A	52 A	65 A	77 A	77 A
		550-600 V AC	41 A	52 A	62 A	77 A	77 A
	Horse power rating (1)	200-208 V AC	10 hp	15 hp	20 hp	25 hp	30 hp
		220-240 V AC	15 hp	20 hp	25 hp	30 hp	30 hp
		440-480 V AC	30 hp	40 hp	50 hp	60 hp	60 hp
		550-600 V AC	40 hp	50 hp	60 hp	75 hp	75 hp
UL / CSA - DC motor starting - 3 poles in series	Full Load Amps (FLA)	125 V DC	40 A	58 A	76 A	76 A	110 A
		250 V DC	38 A	55 A	72 A	89 A	106 A
	Horse power rating	125 V DC	5 hp	7-1/2 hp	10 hp	10 hp	15 hp
		250 V DC	10 hp	15 hp	20 hp	25 hp	30 hp
Short-circuit protection device for contactors without thermal overload relay - Motor protection excluded							
	High fault current	100 kA					
	Fuse rating	150 A	150 A	150 A	200 A	200 A	
	Fuse type, 600 V	J					
Maximum electrical switching frequency							
	For general use	600 cycles/h					
	For motor use	1200 cycles/h					

(1) For the corresponding kW/A or hp/A values of 1500 r.p.m, 50 Hz or 1800 r.p.m, 60 Hz, 3-phase motors, see "Motor rated operational powers and currents".

## AF116 ... AF370 3-pole contactors

### Technical data

#### Main pole - Utilization characteristics according to UL / NEMA / CSA

Contactor types	AC / DC operated	AF116	AF140	AF146	AF190	AF205	AF265	AF305	AF370
Standards		UL 60947-1 / 60947-4-1A and CSA 60947-1 / 60947-4-1A							
Maximum operational voltage		600V							
NEMA size		-	4	-	-	-	5	-	-
NEMA continuous amp rating	Thermal current	-	135 A	-	-	-	270 A	-	-
NEMA maximum horse power ratings									
1-phase, 60 Hz	115 V AC	-	-	-	-	-	-	-	-
	230 V AC	-	-	-	-	-	-	-	-
NEMA maximum horse power ratings									
3-phase, 60 Hz	200 V AC	-	40 hp	-	-	-	75 hp	-	-
	230 V AC	-	50hp	-	-	-	100 hp	-	-
	460 V AC	-	100 hp	-	-	-	200 hp	-	-
	575 V AC	-	100 hp	-	-	-	200 hp	-	-
UL / CSA general use rating									
600 V AC		160 A	200 A	200 A	250 A	300 A	350 A	400 A	520 A
With conductor cross-sectional area		AWG 2/0	AWG 3/0	AWG 3/0	MCM 250	MCM 350 (2)	MCM 500	2//AWG 3/0	2//MCM 300
UL / CSA maximum 1-phase motor rating									
Full load current	120 V AC	-	-	-	-	-	-	-	-
	240 V AC	-	-	-	-	-	-	-	-
Horse power rating	120 V AC	-	-	-	-	-	-	-	-
	240 V AC	-	-	-	-	-	-	-	-
UL / CSA maximum 3-phase motor rating									
Full load current (1)	200-208 V AC	92 A	120 A	120 A	150 A	177 A	221 A	285 A	359 A
	220-240 V AC	104 A	130 A	130 A	154 A	192 A	248 A	312 A	360 A
	440-480 V AC	96 A	124 A	124 A	156 A	180 A	240 A	302 A	361 A
	550-600 V AC	99 A	125 A	125 A	144 A	192 A	242 A	289 A	336 A
Horse power rating (1)	200-208 V AC	30 hp	40 hp	40 hp	50 hp	60 hp	75 hp	100 hp	125 hp
	220-240 V AC	40 hp	50 hp	50 hp	60 hp	75 hp	100 hp	125 hp	150 hp
	440-480 V AC	75 hp	100 hp	100 hp	125 hp	150 hp	200 hp	250 hp	300 hp
	550-600 V AC	100 hp	125 hp	125 hp	150 hp	200 hp	250 hp	300 hp	350 hp
Short-circuit protection device for contactors									
without thermal overload relay - Motor protection excluded									
High fault current		100 kA							
Fuse rating		225 A	250 A	250 A	450 A	400 A	500 A	600 A	800 A
Fuse type, 600 V		J							
Maximum electrical switching frequency									
For general use		300 cycles/h							
For motor use		300 cycles/h							

(1) For the corresponding kW/A or hp/A values of 1500 r.p.m, 50 Hz or 1800 r.p.m, 60 Hz, 3-phase motors, see "Motor rated operational powers and currents".

(2) For conductor cross-sectional area above MCM 300 use terminal enlargements LW205.

# AF09 ... AF38 3-pole contactors

## Technical data

### General technical data

Contactor types	AC / DC operated	AF09	AF12	AF16	AF26	AF30	AF38
Rated insulation voltage Ui		690 V					
acc. to IEC 60947-4-1		600 V					
acc. to UL / CSA		6 kV					
Rated impulse withstand voltage Uimp.		6 kV					
Electromagnetic compatibility		Devices complying with IEC 60947-1 / EN 60947-1 - Environment A and B (1)					
Ambient air temperature close to contactor							
Operation	Fitted with thermal overload relay	-25...+60 °C					
	Without thermal overload relay	-40...+70 °C					
Storage		-60...+80 °C					
Climatic withstand		Category B according to IEC 60947-1 Annex Q					
Maximum operating altitude (without derating)		3000 m					
Mechanical durability							
Number of operating cycles		10 millions operating cycles					
Max. switching frequency		3600 cycles/h					
Shock withstand							
acc. to IEC 60068-2-27 and EN 60068-2-27							
Mounting position 1							
	Shock direction	1/2 sinusoidal shock for 11 ms: no change in contact position, closed or open position					
	A	30 g					
	B1	25 g closed position / 5 g open position					
	B2	15 g					
	C1	25 g					
	C2	25 g					
Vibration withstand		5...300 Hz					
acc. to IEC 60068-2-6		4 g closed position / 2 g open position					

(1) Environment B: all AF09...AF38 produced since week 08.2013.  
 AF09...AF38-...-12 (48 ...130 V 50 / 60 Hz - DC) compliant to environment A only: for environment B, select AF09...AF38Z-...-22.

### Mounting characteristics and conditions for use

Contactor types	AC / DC operated	AF09	AF12	AF16	AF26	AF30	AF38
Mounting positions							
		Max. N.C. built-in and add-on N.C. auxiliary contacts: see accessory fitting details for a 3-pole contactor AF09 ... AF38					
Mounting distances		The contactors can be assembled side by side					
Fixing							
On rail according to IEC 60715, EN 60715		35 x 7.5 mm or 35 x 15 mm					
By screws (not supplied)		2 x M4 screws placed diagonally					



## AF09 ... AF38 3-pole contactors

### Technical data

#### Magnet system characteristics for AF09 ... AF38 contactors - AC / DC operated

Contactor types	AC / DC operated	AF09	AF12	AF16	AF26	AF30	AF38
Coil operating limits acc. to IEC 60947-4-1	AC supply	At $\theta \leq 60^\circ\text{C}$ $0.85 \times U_c \text{ min...}1.1 \times U_c \text{ max.}$ At $\theta \leq 70^\circ\text{C}$ $0.85 \times U_c \text{ min...}U_c \text{ max.}$					
	DC supply	At $\theta \leq 60^\circ\text{C}$ $0.85 \times U_c \text{ min...}1.1 \times U_c \text{ max.}$ At $\theta \leq 70^\circ\text{C}$ $0.85 \times U_c \text{ min...}U_c \text{ max.}$					
AC control voltage 50/60 Hz		24...500 V AC					
Rated control circuit voltage $U_c$		50 VA					
Coil consumption	Average pull-in value	50 VA					
	Average holding value	2.2 VA / 2 W					
DC control voltage		20...500 V DC					
Rated control circuit voltage $U_c$		50 W					
Coil consumption	Average pull-in value	2 W					
	Average holding value	2 W					
PLC-output control		Not suitable for direct control by PLC output					
Drop-out voltage		$\leq 60\%$ of $U_c \text{ min.}$					
Voltage sag immunity acc. to SEMI F47-0706		-					
Dips withstand $-20^\circ\text{C} \leq \theta \leq +60^\circ\text{C}$		-					
Operating time							
Between coil energization and:	N.O. contact closing	40...95 ms					
	N.C. contact opening	38...90 ms					
Between coil de-energization and:	N.O. contact opening	11...95 ms					
	N.C. contact closing	13...98 ms					

#### Magnet system characteristics for AF09Z ... AF38Z 24 DC operated - designed for PLC - coil 30

Contactor types	DC operated	AF09Z	AF12Z	AF16Z	AF26Z	AF30Z	AF38Z
Coil operating limits acc. to IEC 60947-4-1	DC supply	At $\theta \leq 60^\circ\text{C}$ $0.85 \times U_c$ At $\theta \leq 70^\circ\text{C}$ $U_c$					
DC control voltage		24 V DC					
Rated control circuit voltage $U_c$		6 W					
Coil consumption	Average pull-in value	1.7 W					
	Average holding value	1.7 W					
PLC-output control		$\geq 250 \text{ mA}$ 24 V DC for PLCs and safety PLCs using broken wire detection					
Drop-out voltage		$\leq 60\%$ of $U_c \text{ min.}$					
Operating time							
Between coil energization and:	N.O. contact closing	27...53 ms					
	N.C. contact opening	20...35 ms					
Between coil de-energization and:	N.O. contact opening	17...29 ms					
	N.C. contact closing	22...57 ms					

#### Magnet system characteristics for AF09Z ... AF38Z for specific applications - coils 20, 21, 22, 23

Contactor types	AC / DC operated	AF09Z	AF12Z	AF16Z	AF26Z	AF30Z	AF38Z
Coil operating limits acc. to IEC 60947-4-1	AC supply	At $\theta \leq 60^\circ\text{C}$ $0.85 \times U_c \text{ min...}1.1 \times U_c \text{ max.}$ At $\theta \leq 70^\circ\text{C}$ $0.85 \times U_c \text{ min...}U_c \text{ max.}$					
	DC supply	At $\theta \leq 70^\circ\text{C}$ $0.85 \times U_c \text{ min...}1.1 \times U_c \text{ max.}$					
AC control voltage		24...250 V AC					
Rated control circuit voltage $U_c$		16 VA					
Coil consumption	Average pull-in value	1.7 VA / 1.5 W					
	Average holding value	1.7 VA / 1.5 W					
DC control voltage		12...250 V DC					
Rated control circuit voltage $U_c$		12...16 W					
Coil consumption	Average pull-in value	1.7 W					
	Average holding value	1.7 W					
PLC-output control		(AF..Z coil 21) $\geq 500 \text{ mA}$ 24 V DC for PLCs - not suitable for safety PLCs					
Drop-out voltage		$\leq 60\%$ of $U_c \text{ min.}$					
Voltage sag immunity acc. to SEMI F47-0706		(AF..Z coil 21, 22, 23) conditions of use on request					
Dips withstand $-20^\circ\text{C} \leq \theta \leq +60^\circ\text{C}$		(AF..Z coil 21, 22, 23) 20 ms average for $U_c \geq 24 \text{ V}$ 50/60 Hz or $U_c \geq 20 \text{ V}$ DC					
Operating time							
Between coil energization and:	N.O. contact closing	40...95 ms					
	N.C. contact opening	38...90 ms					
Between coil de-energization and:	N.O. contact opening	11...95 ms					
	N.C. contact closing	13...98 ms					

# AF40 ... AF96 3-pole contactors

## Technical data

### General technical data

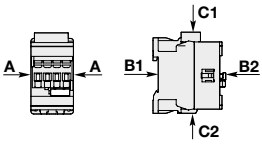
Contactor types	AC / DC operated	AF40	AF52	AF65	AF80	AF96
Rated insulation voltage Ui acc. to IEC 60947-4-1 acc. to UL / CSA		690 V 600 V			1000 V	
Rated impulse withstand voltage Uimp.		6 kV			8 kV	
Electromagnetic compatibility		Devices complying with IEC 60947-1 / EN 60947-1 - Environment A and B (1)				
Ambient air temperature close to contactor						
Operation	Fitted with thermal overload relay	-40...+70 °C				
	Without thermal overload relay	-40...+70 °C				
Storage		-60...+80 °C				
Climatic withstand		Category B according to IEC 60947-1 Annex Q				
Maximum operating altitude (without derating)		3000 m				
Mechanical durability						
Number of operating cycles		10 millions operating cycles				
Max. switching frequency		3600 cycles/h				
Shock withstand acc. to IEC 60068-2-27 and EN 60068-2-27						
Mounting position 1						
	Shock direction	1/2 sinusoidal shock for 11 ms: no change in contact position, closed or open position				
	A	25 g				
	B1	25 g closed position / 5 g open position				
	B2	15 g				
	C1	25 g				
C2	25 g					
Vibration withstand acc. to IEC 60068-2-6		5...300 Hz 3 g closed position / 3 g open position				

### Magnet system characteristics

Contactor types	AC / DC operated	AF40	AF52	AF65	AF80	AF96
Coil operating limits acc. to IEC 60947-4-1	AC supply	At $\theta \leq 70^\circ\text{C}$ $0.85 \times U_c \text{ min} \dots 1.1 \times U_c \text{ max}$ .				
	DC supply	At $\theta \leq 70^\circ\text{C}$ $0.85 \times U_c \text{ min} \dots 1.1 \times U_c \text{ max}$ .				
AC control voltage 50/60 Hz						
Rated control circuit voltage $U_c$		24...500 V AC				
Coil consumption	Average pull-in value	25 VA			40 VA	
	Average holding value	4 VA / 2 W				
DC control voltage						
Rated control circuit voltage $U_c$		20...500 V AC				
Coil consumption	Average pull-in value	25 W			40 W	
	Average holding value	2 W				
PLC-output control		-				
Drop-out voltage		$\leq 60\%$ of $U_c \text{ min}$ .				
Voltage sag immunity acc. to SEMI F47-0706		conditions of use on request				
Dips withstand $-20^\circ\text{C} \leq \theta \leq +60^\circ\text{C}$		20 ms average				
Operating time						
Between coil energization and:	N.O. contact closing	42...100 ms				
	N.C. contact opening	38...95 ms				
Between coil de-energization and:	N.O. contact opening	17...100 ms				
	N.C. contact closing	19...105 ms				

### Mounting characteristics and conditions

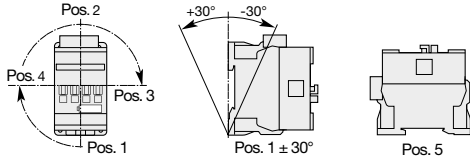
Contactor types	AC / DC operated	AF40	AF52	AF65	AF80	AF96
Mounting positions						
		Max. N.C. built-in and add-on N.C. auxiliary contacts: see accessory fitting details for a 3-pole contactor AF40 ... AF96				
Mounting distances		The contactors can be assembled side by side				
Fixing						
On rail according to IEC 60715, EN 60715		35 x 7.5 mm or 35 x 15 mm			35 x 15 mm	
By screws (not supplied)		2 x M4 or 2 x M6 screws placed diagonally				

# AF116 ... AF370 3-pole contactors

## Technical data

### General technical data

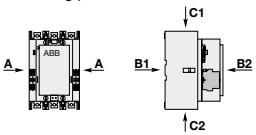
Contactor types	AC / DC operated	AF116	AF140	AF146	AF190	AF205	AF265	AF305	AF370
Rated insulation voltage Ui		1000 V							
acc. to IEC 60947-4-1		600 V							
acc. to UL / CSA		8 kV							
Rated impulse withstand voltage Uimp.		AF contactors comply with IEC 60947-1 / EN 60947-1 - Environment A							
Electromagnetic compatibility		AF contactors comply with IEC 60947-1 / EN 60947-1 - Environment A							
Ambient air temperature close to contactor		-25 to +55 °C							
Operation	Fitted with thermal overload relay	-40 to +70 °C							
	Without thermal overload relay	-40 to +70 °C							
Storage		-40 to +70 °C							
Climatic withstand		Category B according to IEC 60947-1 Annex Q							
Maximum operating altitude (without derating)		3000 m							
Mechanical durability		5 million operating cycles							
Number of operating cycles		300 cycles/h							
Maximum switching frequency		No change in contact position, closed or open position							
Shock withstand		Shock direction							
acc. to IEC 60068-2-27 and EN 60068-2-27		1/2 sinusoidal shock for 11 ms				1/2 sinusoidal shock for 30 ms			
Mounting position 1									
		A	20 g			20 g			
		B1	15 g closed position / 3 g open position			15 g closed position / 3 g open position			
		B2	15 g closed position / 3 g open position			15 g closed position / 3 g open position			
		C1	20 g			20 g			
		C2	20 g			20 g			
Vibration withstand		0.7 g closed position / 0.7 g open position 13.2...100 Hz							
acc to IEC 60068-2-6									

### Magnet system characteristics

Contactor types	AC / DC operated	AF116	AF140	AF146	AF190	AF205	AF265	AF305	AF370
Coil operating limits	AC supply	At $\theta \leq 70^\circ\text{C}$ $0.85 \times U_c \text{ min} \dots 1.1 \times U_c \text{ max}$							
acc. to IEC 60947-4-1	DC supply	At $\theta \leq 70^\circ\text{C}$ $0.80 \times U_c \text{ min} \dots 1.1 \times U_c \text{ max}$							
Rated control circuit voltage $U_c$ (1)		24...500 V AC, 20...500 V DC							
Coil consumption									
AC control voltage 50/60 Hz									
24...60 V AC	Average pull-in value	225 VA			165 VA		475 VA		
	Average holding value	5.5 VA			6 VA		8.5 VA		
48...130 V AC	Average pull-in value	170 VA			175 VA		340 VA		
	Average holding value	4 VA			4 VA		17 VA		
100...250 V AC	Average pull-in value	130 VA			220 VA		385 VA		
	Average holding value	6 VA			7 VA		17.5 VA		
250...500 V AC	Average pull-in value	205 VA			185 VA		420 VA		
	Average holding value	16 VA			16 VA		21 VA		
DC control voltage									
20...60 V DC	Average pull-in value	210 W			205 W		400 W		
	Average holding value	2.5 W			2.5 W		3.5 W		
48...130 V DC	Average pull-in value	130 W			130 W		360 W		
	Average holding value	2.5 W			2.5 W		2.5 W		
100...250 V DC	Average pull-in value	135 W			190 W		410 W		
	Average holding value	3 W			2.5 W		4.5 W		
250...500 V DC	Average pull-in value	205 W			190 W		600 W		
	Average holding value	4 W			4 W		4.7 W		
Drop-out voltage		55 % of $U_c \text{ min}$							
Voltage sag immunity acc. to SEMI F47		Conditions of use on request							
Dips withstand		$\geq 20 \text{ ms}$							
Operating time									
Coil supply between A1 - A2									
Between coil energization and:	N.O. contact closing	20...55 ms			25...60 ms		30...60 ms		
Between coil de-energization and (2):	N.O. contact opening	40...70 ms			45...80 ms		45...80 ms		

(1) For more detailed data, please consult your ABB local sales organization

(2) Less than 20ms when using coil code -33 and -34

### Mounting characteristics and conditions for use

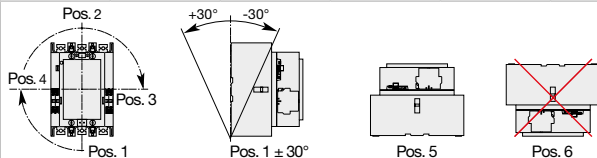
Contactor types	AC / DC operated	AF116	AF140	AF146	AF190	AF205	AF265	AF305	AF370
Mounting positions									
Mounting distances		Max. add-on N.O. or N.C. auxiliary contacts: see accessory fitting details for 3-pole contactor AF116 ... AF370							
Fixing		The contactors can be assembled side by side							
On rail acc. to IEC 60715, EN 60715		-							
By screws		4 x M4				4 x M5			